

BL'NDSPACE[®]

PRODUCT BOOK 2024

STANDARD **S** SERIES

The standard for hiding roller blinds.

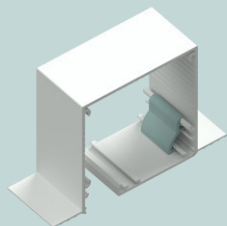

S100x100SS

ARTICLE: 56002

EXAMPLE USE:
Head Box, two skim coat
flanges (Std Roller Blinds)

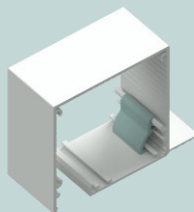

S100x100NS

ARTICLE: 56001

EXAMPLE USE:
Head Box, one skim coat
flange (Std Roller Blinds)

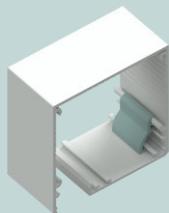

S100x100NN

ARTICLE: 56000

EXAMPLE USE:
Head Box, no flanges (Std
Roller Blinds, <2400mm
width)

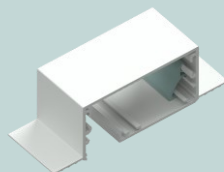

S100x50SS

ARTICLE: 56030

EXAMPLE USE:
Side Box for side channels,
two skim coat flanges

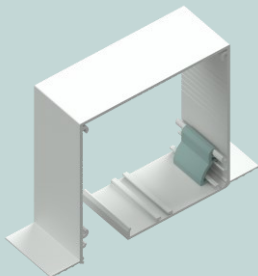

S130x130SS

ARTICLE: 56022

EXAMPLE USE:
Head Box, two skim coat
flanges (L Roller Blinds)

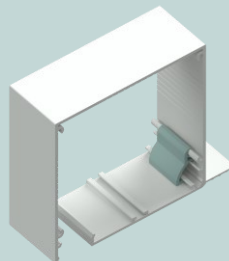

S130x130NS

ARTICLE: 56021

EXAMPLE USE:
Head Box, one skim coat
flange (L Roller Blinds)

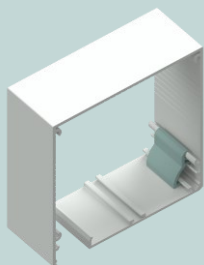

S130x130NN

ARTICLE: 56020

EXAMPLE USE:
Head Box, no flanges (L
Roller Blinds, <4000mm
width)

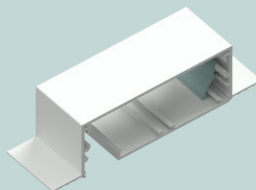

S130x50SS

ARTICLE: 56035

EXAMPLE USE:
Side Box for side channels,
two skim coat flanges



CH25

ARTICLE: 86030

Product Information:
Cover Hinge sold in packs of 25
pcs. (included with boxes)



Wall Mount

ARTICLE: 86020

Product Information:
Wall mount for installation
without Head Box

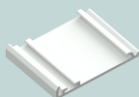

C65

ARTICLE: 86014

Product Information:
Cover 65mm if sold separately
(included with boxes)

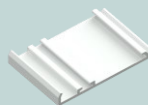

C75

ARTICLE: 86015

Product Information:
Cover 75mm if sold separately
(included with boxes)

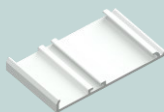

C85

ARTICLE: 86016

Product Information:
Cover 85mm if sold separately
(included with boxes)

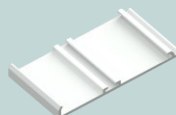

C92

ARTICLE: 86010

Product Information:
Cover 92mm if sold separately
(included with boxes)

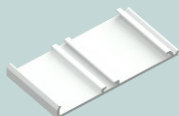

C95

ARTICLE: 86017

Product Information:
Cover 95mm if sold separately
(included with boxes)

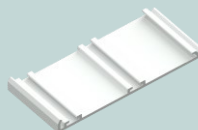

C115

ARTICLE: 86011

Product Information:
Cover 115mm if sold separately
(included with boxes)

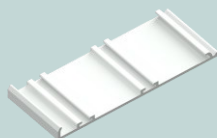

C122

ARTICLE: 86018

Product Information:
Cover 122mm if sold separately
(included with boxes)

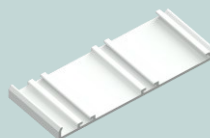

C125

ARTICLE: 86012

Product Information:
Cover 125mm if sold separately
(included with boxes)



SEC100x100

ARTICLE: 56101

Product Information:
End Cap for S100x100



SEC100x50

ARTICLE: 56102

Product Information:
End Cap for S100x50



SEC130x130

ARTICLE: 56110

Product Information:
End Cap for S130x130



SEC130x50

ARTICLE: 56111

Product Information:
End Cap for S130x50

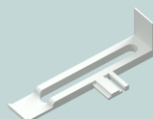

CG65

ARTICLE: 86040

Product Information:
Chain Guide for chain
operated blinds 65mm
cover

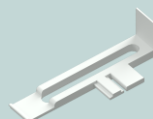

CG75

ARTICLE: 86041

Product Information:
Chain Guide for chain
operated blinds 75mm
cover



CG85

ARTICLE: 86042

Product Information:
Chain Guide for chain
operated blinds 85mm
cover



CG95

ARTICLE: 86043

Product Information:
Chain Guide for chain
operated blinds 95mm
cover

MODULAR **M** SERIES

Superior blinds concealment.

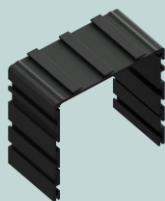

M100x100

ARTICLE: 60101

Product Information:
Back Box for M 100x100
System

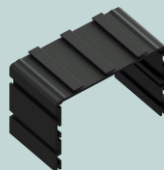

M100x70

ARTICLE: 60103

Product Information:
Side Box for M100x100
System

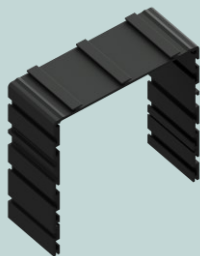

M130x130

ARTICLE: 60100

Product Information:
Back Box for M 130x130
System

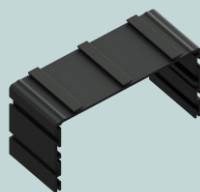

M130x70

ARTICLE: 60102

Product Information:
Side Box for M 130x130
System



MC50

ARTICLE: 60109

Product Information:
Modular Cover 50mm

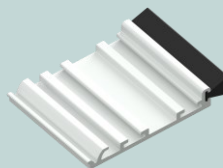

MCB60

ARTICLE: 60117

Product Information:
Modular Cover with Brush,
60mm

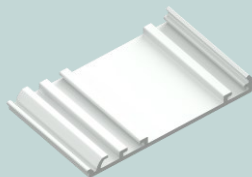

MC80

ARTICLE: 60108

EXAMPLE USE:
Modular Cover 80mm

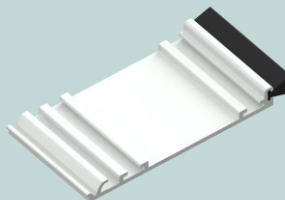

MCB90

ARTICLE: 60118

Product Information:
Modular Cover with Brush,
90mm

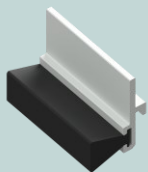

MBH

ARTICLE: 60119

Product Information:
Modular Brush Holder for
Box

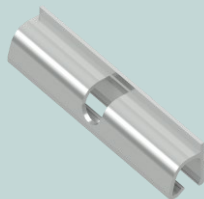

MCH

ARTICLE: 60110

Product Information:
Modular Cover Hinge



MSF

ARTICLE: 60111

Product Information:
Modular Skim Coat Flange



MPF

ARTICLE: 60112

Product Information:
Modular Visible Plain
Flange



MSC70

ARTICLE: 60106

Product Information:
Modular Side Cover 70mm



MSC100

ARTICLE: 60105

Product Information:
Modular Side Cover 100mm



MSC130

ARTICLE: 60104

EXAMPLE USE:
Modular Side Cover
130mm



MWB

ARTICLE: 60107

Product Information:
Modular Wall Bracket



MWH

ARTICLE: 60114

Product Information:
Modular Wall Hinge for
installation without Head
Box



MBB1

ARTICLE: 60113

Product Information:
Modular Blind Bracket for
Lutron Bracket



MEC100x100

ARTICLE: 63101

Product Information:
End Cap for M100x100



MEC100x70

ARTICLE: 63103

Product Information:
End Cap for M100x70



MEC130x130

ARTICLE: 63100

Product Information:
End Cap for M130x130



MEC130x70

ARTICLE: 63102

Product Information:
End Cap for M130x70

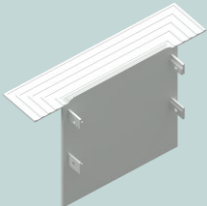

MEC100x100S

ARTICLE: 63120

Product Information:
End Cap for M100x100 with
Skim Coat Flange

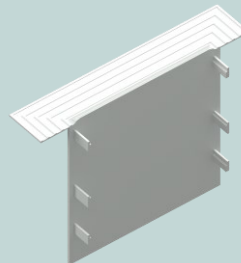

MEC130x130S

ARTICLE: 63110

Product Information:
End Cap for M130x130 with
Skim Coat Flange



Sample Configurations

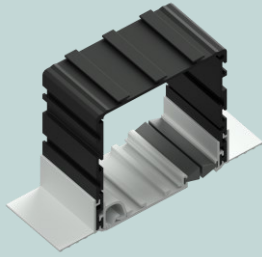

ITEMS USED:

- M100x100
- MSF x2
- MCB60
- MCH
- MBH

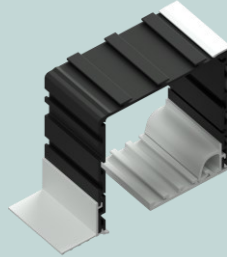

ITEMS USED:

- M100x100
- MSF
- MC50
- MCH
- MSC100

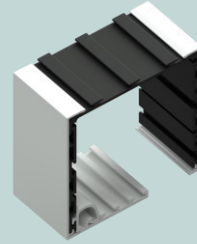

ITEMS USED:

- M100x100
- MC50
- MCH
- MSC100 x2

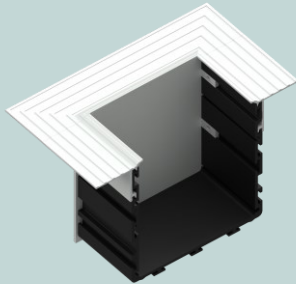

ITEMS USED:

- M100x100
- MSF x2
- MEC100x100S

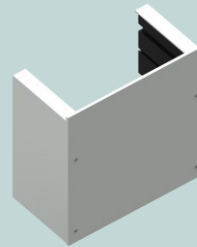

ITEMS USED:

- M100x100
- MSC100
- MEC100x100

CUSTOM **C** SERIES

Custom sizes for all blind types.

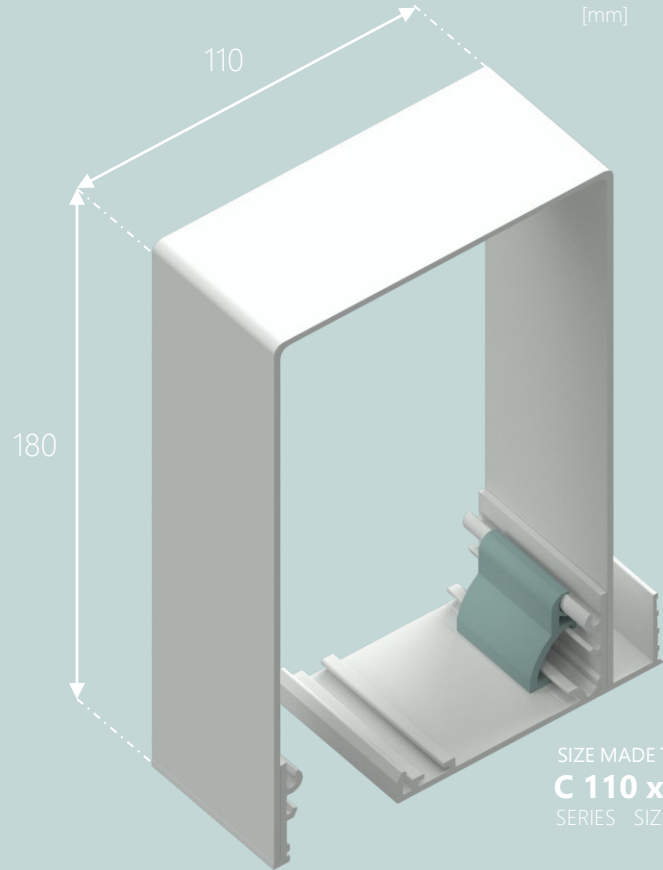

Box Corners

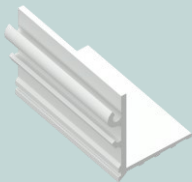

S

Skim coat flange

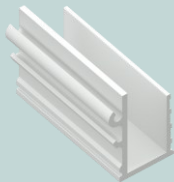

U

Upstand flange

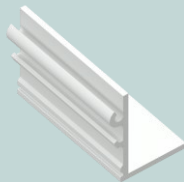

V

Visible plain flange

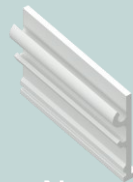

N

No flange

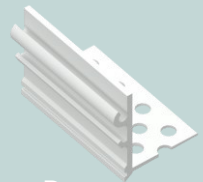

P

Perforated flange

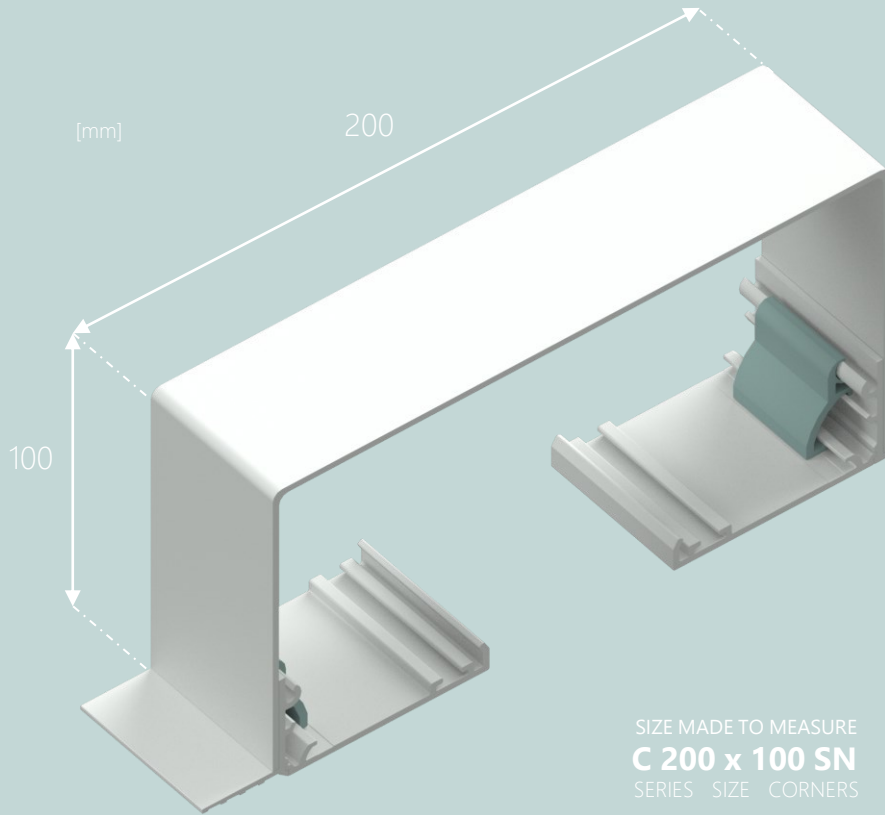

Box Corners

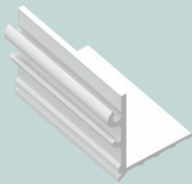

S

Skim coat flange

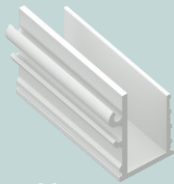

U

Upstand flange

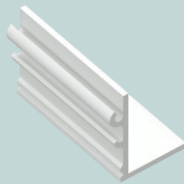

V

Visible plain flange

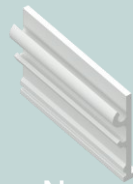

N

No flange

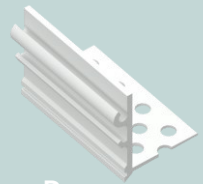

P

Perforated flange

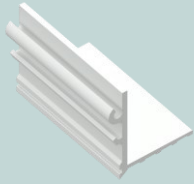

S CORNER

ARTICLE: 87002

Product Information:
Skim coat flange front
corner for local fabrication

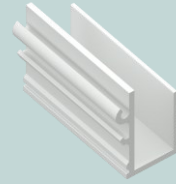

U CORNER

ARTICLE: 87001

Product Information:
Ustand flange front corner
for local fabrication

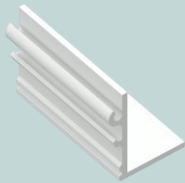

V CORNER

ARTICLE: 87003

Product Information:
Visible plain flange corner
for local fabrication

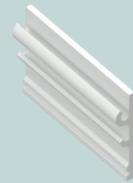

N CORNER

ARTICLE: 87000

Product Information:
No flange front corner for
local fabrication

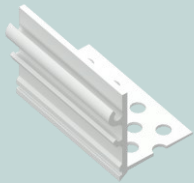

P CORNER

ARTICLE: 87004

Product Information:
Perforated skim coat front
corner for local fabrication



DOUBLE- SIDED TAPE

ARTICLE: 87105 (raw)

ARTICLE: 87110 (pc)

Product Information:
Used to attach font corners
to the custom back boxes

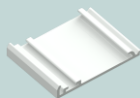

C65

ARTICLE: 86014

Product Information:
Cover 65mm if sold separately
(included with boxes)

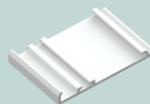

C75

ARTICLE: 86015

Product Information:
Cover 75mm if sold separately
(included with boxes)

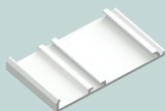

C85

ARTICLE: 86016

Product Information:
Cover 85mm if sold separately
(included with boxes)

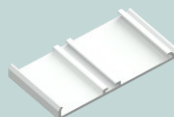

C92

ARTICLE: 86010

Product Information:
Cover 92mm if sold separately
(included with boxes)

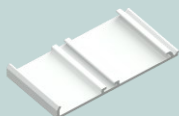

C95

ARTICLE: 86017

Product Information:
Cover 95mm if sold separately
(included with boxes)

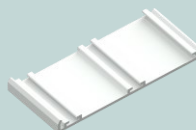

C115

ARTICLE: 86011

Product Information:
Cover 115mm if sold separately
(included with boxes)

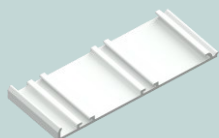

C122

ARTICLE: 86018

Product Information:
Cover 122mm if sold
separately (included with
boxes)

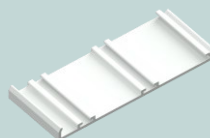

C125

ARTICLE: 86012

Product Information:
Cover 125mm if sold
separately (included with
boxes)

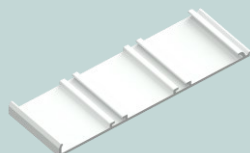

C150

ARTICLE: 86013

Product Information:
Cover 150mm if sold
separately (included with
boxes)

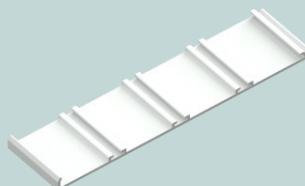

C200

ARTICLE: 86019

Product Information:
Cover 200mm if sold
separately (included with
boxes)

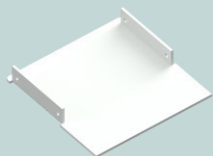

CEC Small

ARTICLE: 53023

Product Information:
Custom End Cap up to
100x100mm

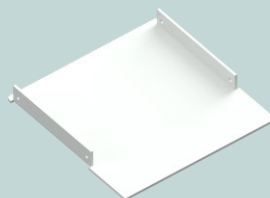

CEC Medium

ARTICLE: 53024

Product Information:
Custom End Cap above
100x100 up to 130x130mm



CEC Large

ARTICLE: 53025

Product Information:
Custom End Cap above
130x130 up to 155x155mm

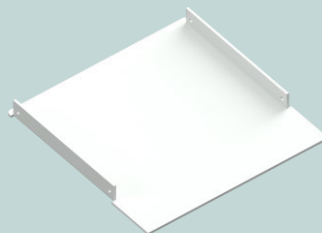

CEC Extra Large

ARTICLE: 53026

Product Information:
Custom End Cap above
155x155mm

BOX ACCESSORIES

To align and connect boxes and covers.



SPLI1

ARTICLE: 53100

Splice pin to align boxes
and Trackrim tracks



SPLA1

ARTICLE: 53010

Splice plate with screws to
align cover plates



HG1

ARTICLE: 56130

Grommet for Cable Entry

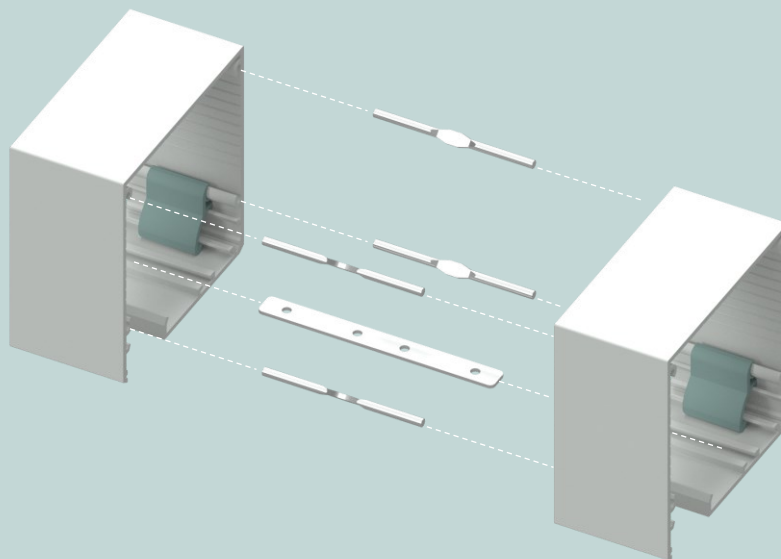

PELMET P SERIES

Custom pelmets to hide blinds.



P61x128

ARTICLE: 55000

Product Information:
Face-fix Pelmet 128mm
high



P61x153

ARTICLE: 55005

Product Information:
Face-fix Pelmet 153mm
high



P61x203

ARTICLE: 55010

Product Information:
Cover 85mm if sold Face-fix
Pelmet 203mm high



P90x128

ARTICLE: 55020

Product Information:
Extended Face-fix Pelmet
128mm high



P90x153

ARTICLE: 55025

Product Information:
Extended Face-fix Pelmet
153mm high



P90x203

ARTICLE: 55030

Product Information:
Extended Face-fix Pelmet
203mm high

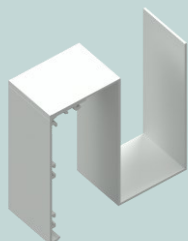

P130x128 S-Shape

ARTICLE: 55045

Product Information:
Surface-Mounted S-Shaped
Pelmet

TRACKTRIM

Superior recessed curtain track system.

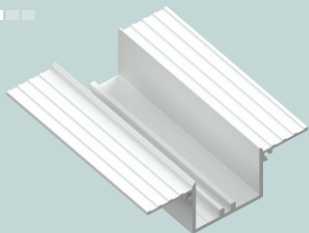

TT1F

ARTICLE: 71002

Product Information:
Tracktrim Track with Screw
Channel

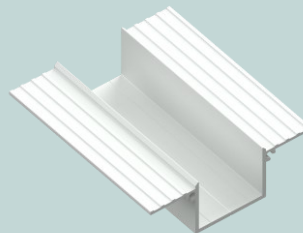

TT2F

ARTICLE: 71003

Product Information:
Tracktrim Track without
Screw Channel

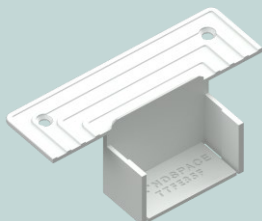

TTFF35F

ARTICLE: 70072

Product Information:
Flat Ends w Flange for
Manual 35mm Curtain
Tracks



TTFF35

ARTICLE: 70071

Product Information:
Flat Ends for Manual 35mm
Curtain Tracks

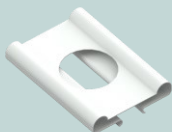

CTP

ARTICLE: 60070

Product Information:
Curtain Track Protector



SPLI1

ARTICLE: 53100

Product Information:
Long splice pin to align
boxes and Tracktrim tracks



SPLI2

ARTICLE: 53111

Product Information:
Short splice pin to connect
curved sections



AKFB

ARTICLE: 60073

Product Information:
Allen Key for Grub Screw in
Fixing Brackets

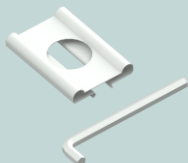

CTIK2

ARTICLE: 70090

Product Information:
Curtain Track Installation Kit
(CTP, AKFB)

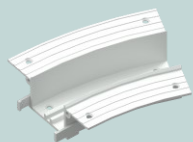

TTCR250

ARTICLE: 70059

Product Information:
Curved Section 22.5
Degrees with 250mm
Radius

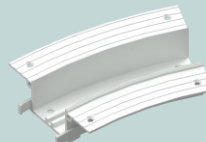

TTCR290

ARTICLE: 70060

Product Information:
Curved Section 22.5
Degrees with 290mm
Radius



TTCR300

ARTICLE: 70061

Product Information:
Curved Section 22.5
Degrees with 300mm
Radius



TTCR330

ARTICLE: 70062

Product Information:
Curved Section 22.5
Degrees with 330mm
Radius



TTCR365

ARTICLE: 70065

Product Information:
Curved Section 22.5
Degrees with 365mm
Radius



TTCR440

ARTICLE: 70066

Product Information:
Curved Section 22.5
Degrees with 440mm
Radius



TTCR480

ARTICLE: 70067

Product Information:
Curved Section 22.5
Degrees with 480mm
Radius



TTCR508

ARTICLE: 70063

Product Information:
Curved Section 22.5
Degrees with 508mm
Radius



TTLCRB1F

ARTICLE: 70043

One-Piece Corner section for Butt-Jointed Lutron Return Ends

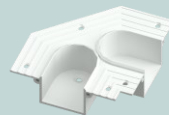

TTSCRB1F

ARTICLE: 70044

One-Piece Corner section for Butt-Jointed Somfy Return Ends



TTSG51CRB1F

ARTICLE: 70045

One-Piece Corner section for Butt-Jointed Silent Gliss 5100 Return Ends



TTSG56CRB1F

ARTICLE: 70046

One-Piece Corner section for Butt-Jointed Silent Gliss 5600 Return Ends



TTLMB1F

ARTICLE: 70021

Product Information:
Motor Box w Flanges for
Lutron System

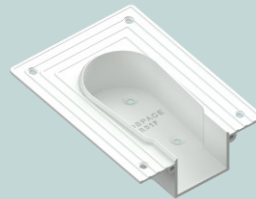

TTLRB1F

ARTICLE: 70022

Product Information:
Return Box w Flanges for
Lutron System



TTL1

ARTICLE: 71012

Product Information:
Fixing Bracket for Lutron
Curtain Track

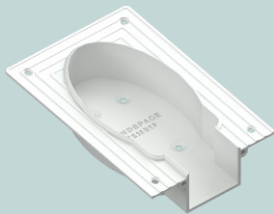

TTSMB1F

ARTICLE: 71023

Product Information:
Motor Box w Flanges for
Somfy System

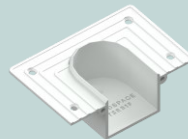

TTSRB1F

ARTICLE: 70024

Product Information:
Return Box w Flanges for
Somfy System

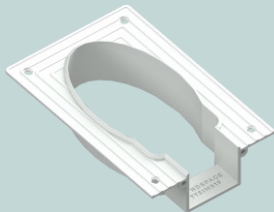

TTSIMB1F

ARTICLE: 70032

Product Information:
Motor Box w Flanges for
inverted install for Somfy



TTS1

ARTICLE: 70016

Product Information:
Fixing Bracket for Somfy
Glydea Curtain Track



TTSG51MB1F

ARTICLE: 70029

Product Information:
Motor Box w Flanges for
Silent Gliss 5100 System

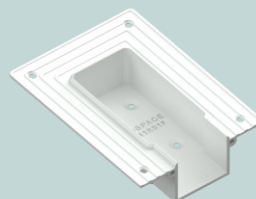

TTSG51RB1F

ARTICLE: 70030

Product Information:
Return Box w Flanges for
Silent Gliss 5100 System



TTSG1

ARTICLE: 71014

Product Information:
Fixing Bracket for Silent
Gliss 5100 Curtain Track



TTSG56MB1F

ARTICLE: 70025

Product Information:
Motor Box w Flanges for
Silent Gliss 5600 System

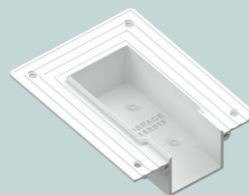

TTSG56RB1F

ARTICLE: 70026

Product Information:
Return Box w Flanges for
Silent Gliss 5600 System



TTSG2

ARTICLE: 71015

Product Information:
Fixing Bracket for Silent
Gliss 5600 Curtain Track



TTQMB1F

ARTICLE: 70027

Product Information:
Motor Box w Flanges for
Qmotion System

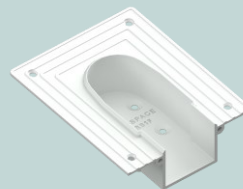

TTQRB1F

ARTICLE: 70028

Product Information:
Return Box w Flanges for
Qmotion System

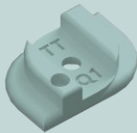

TTQ1

ARTICLE: 71013

Product Information:
Fixing Bracket for Qmotion
Curtain Track



TTCMB1F

ARTICLE: 70033

Product Information:
Motor Box w Flanges for
Crestron System

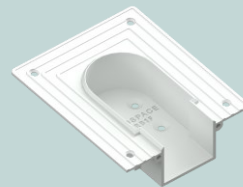

TTCRB1F

ARTICLE: 70034

Product Information:
Return Box w Flanges for
Crestron System

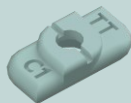

TTC1

ARTICLE: 71011

Product Information:
Fixing Bracket for Crestron
Curtain Track



TTGMB1F

ARTICLE: 70035

Product Information:
Motor Box w Flanges for
Goelst System



TTG1

ARTICLE: 71017

Product Information:
Fixing Bracket for Goelst
Track



TTEMB1F

ARTICLE: 70037

Product Information:
Motor Box w Flanges for
Erfal System

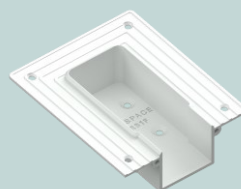

TTERB1F

ARTICLE: 70038

Product Information:
Return Box w Flanges for
Erfal System



TTE1

ARTICLE: 71018

Product Information:
Fixing Bracket for Erfal
Curtain Track



TTTMB1F

ARTICLE:70039

Product Information:
Motor Box w Flanges for Trietex
1 System

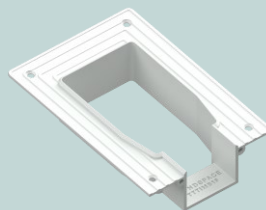

TTTIMB1F

ARTICLE:70042

Product Information:
Inverted Motor Box w Flanges
for Trietex 1 System

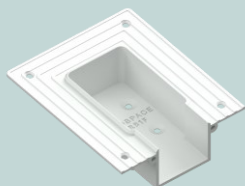

TTTRB1F

ARTICLE: 70040

Product Information:
Return Box w Flanges for Trietex
1 System

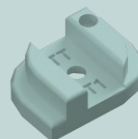

TTT1

ARTICLE: 71020

Product Information:
Fixing Bracket for Trietex Curtain
Track

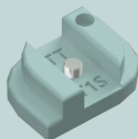

TTTS1

ARTICLE: 71020

Product Information:
Fixing Bracket for Trietex Curtain
Track with screw



Sample Configuration

ITEMS USED:

- TT1F
- TTL1

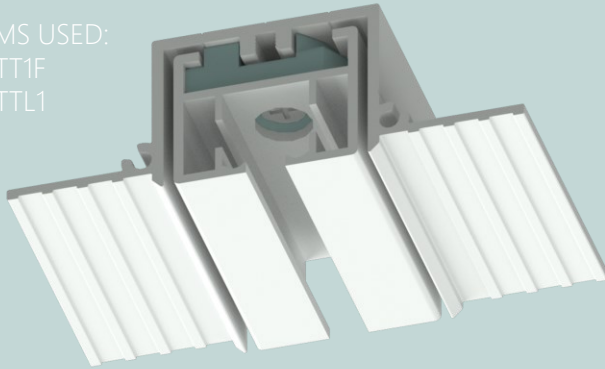

ITEMS USED:

- LMB1F
- LRB1F
- RT1F x2
- RTCR250 x4

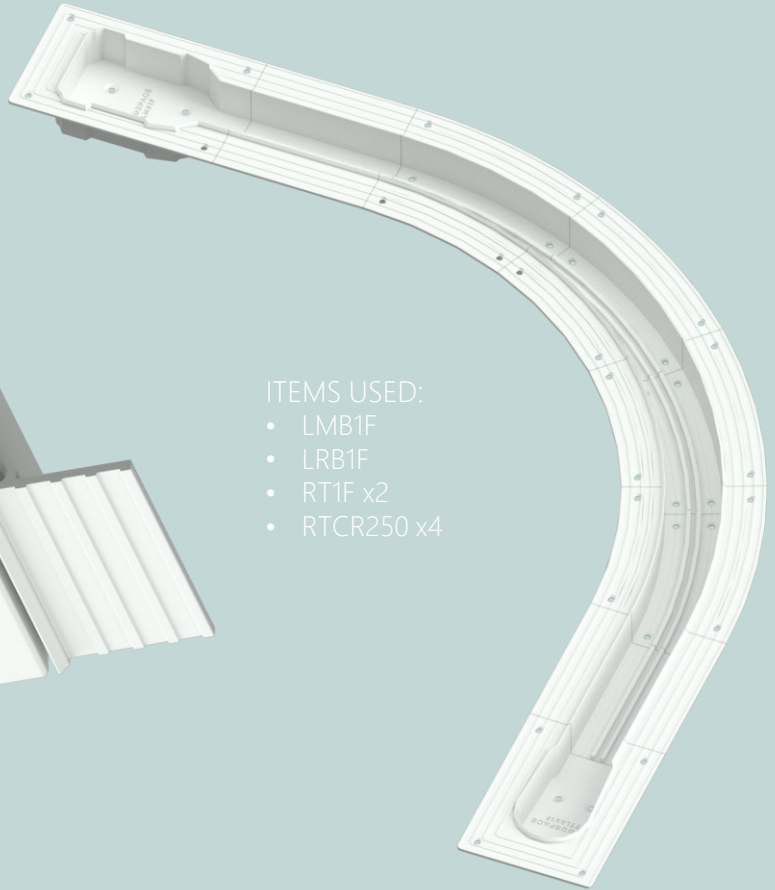

BESPOKE SERVICES

Custom cutting and other bespoke requirements.

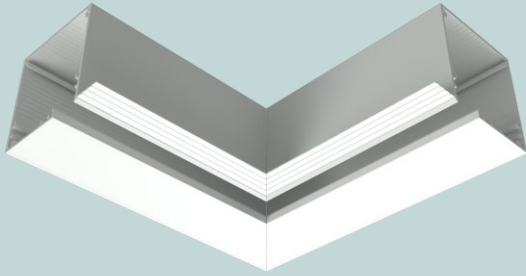

OUTSIDE CORNER
BLINDS TOWARDS ROOM

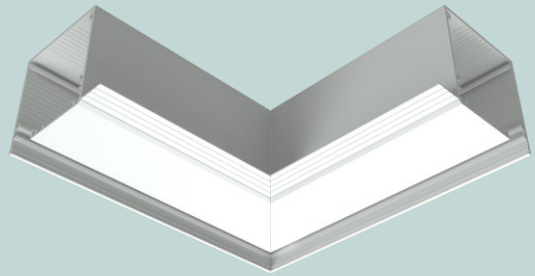

OUTSIDE CORNER
BLINDS TOWARDS WINDOW

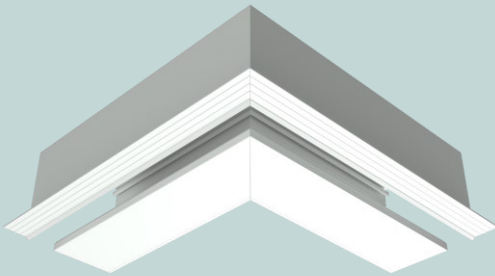

INSIDE CORNER
BLINDS TOWARDS ROOM

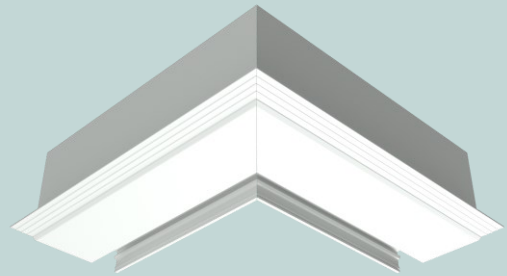

INSIDE CORNER
BLINDS TOWARDS WINDOW

THANK YOU!

Please feel free to get in touch:

sales@blindspace.com

+44 20 8798 3945